



30" Electric Range with the EvenTemp™

Electric Range

Available Products: FCRE3062AB, FCRE3062AS, FCRE3062AW

Available Colors: Black, Stainless Steel, White

Version: 09/23

Product Specifications

Cooking Controls

Bake	Yes
Broil	Yes
Clock	Yes
Cook Time	Yes
Delay Clean	Yes
Delay Start	Yes
Keep Warm	Yes
Kitchen Timer	Yes
Light	Yes
Lockout	Yes
Off	Yes
Oven Light	Yes
Set Clock	Yes
Start	Yes
Steam Clean	Yes
Temperature Display	Yes
Timer On / Off	Yes
Up / Down Arrow	Yes
User Preferences	Yes
Warm Zone	Yes

Oven

Bake Element	2500 Watts
Bake Element Pass	8
Bake Element Type	Hidden
Broil Element	3000 Watts
Broil Element Pass	4
Number of Rack Positions	6
Oven Interior Color	Midnight Black
Oven Light Quantity	1
Oven Light Type	Halogen
Oven Light Watts	40 Watts
Rack Position Type	Embossed
Rack Type 1	Flat
Rack Type 1 Quantity	2

Cooking Controls Function

Adjustable Volume Feedback	Yes
Change between Continuous Bake Setting or 12-Hour	Yes
Energy Saving Feature	
Delayed Bake	Yes
Program Fahrenheit or Celsius	Yes

Cooktop

Cooking Surface Type	Smooth
Element On Indicator Light	Yes
Hot-Surface Indicator Light	Yes
Keep Warm Zone Light	Yes

Drawer

Drawer Handle Style	Integrated
Drawer Type	Storage

Display

Control Location	Rear
Display Interface Color	White
Display Type	Membrane

Electrical Specifications

Connected Load @ 240V	12 kW
Minimum Circuit Required	40 Amps
Voltage Rating	240 V

General Specifications

Prop 65 Label	Yes
Warranty - Labor	1 Year
Warranty - Parts	1 Year

Available Products: FCRE3062AB, FCRE3062AS,

Available Colors: Black, Stainless Steel, White

FCRE3062AW

Version: 09/23

Cooktop Performance

Right Front Element Burner Size	9"
Right Rear Element Burner Size	6"
Left Front Element Burner Size (Small)	6"
Left Front Element Burner Size (Large)	9"
Left Rear Element Burner Size	6"
Right Front Element Burner	3200 Watts
Right Rear Element Burner	1200 Watts
Left Front Element Burner (Small)	1400 Watts
Left Front Element Burner (Large)	3000 Watts
Left Rear Element Burner	1200 Watts
Center Rear Element Burner	100 Watts
Keep Warm Burner Location	Center Rear

Controls

Control Lock	Yes
--------------	-----

Dimensions and Volume

Minimum Height	46 3/4"
Maximum Height	47 3/4"
Width	30"
Depth	26"
Depth With Door 90° Open	47 5/16"
Depth With Handle	28 1/2"
Oven Interior Height	18 1/8"
Oven Interior Width	25 3/16"
Oven Interior Depth	19 7/8"
Oven Capacity	5.3 Cu. Ft.

Installation

Adjustable Leveling Legs	Yes
--------------------------	-----

Safety Certifications and Approvals

UL Listed	Yes
RoHS	Yes

Installation Diagram

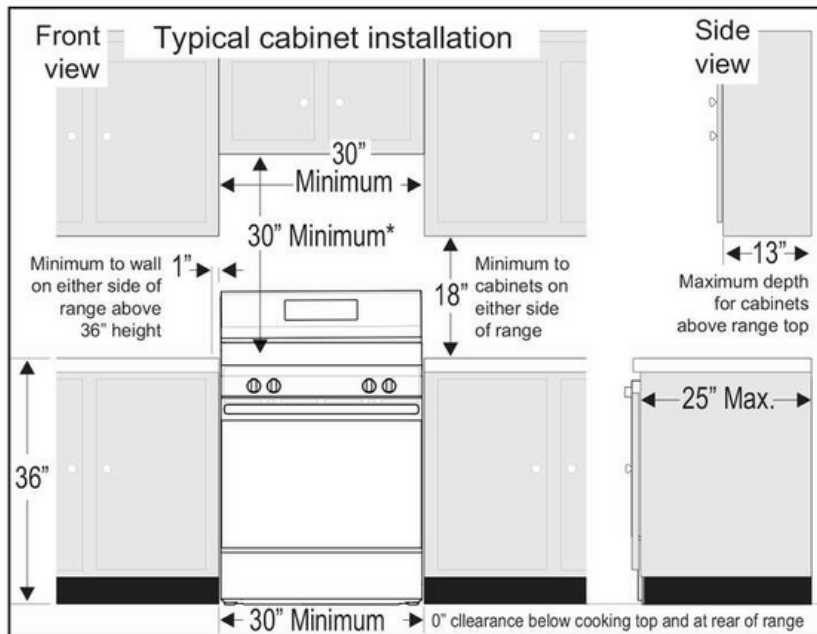

Fig. 1

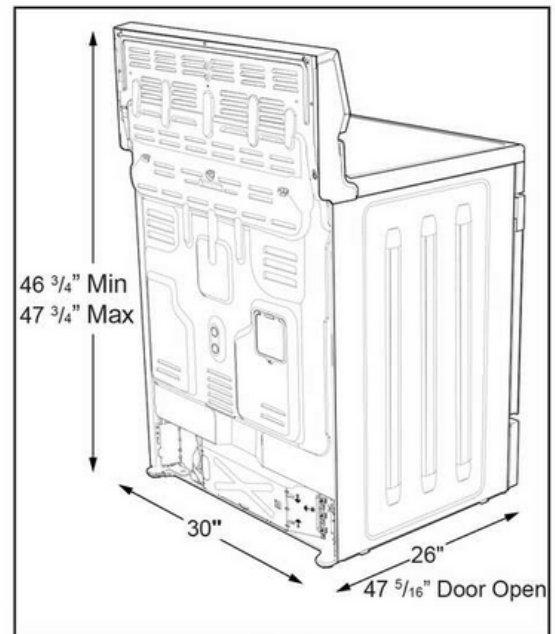

Fig. 2

*30" (762 mm) MINIMUM CLEARANCE BETWEEN THE TOP OF THE COOKING SURFACE AND THE BOTTOM OF AN UNPROTECTED WOOD OR METAL CABINET; OR 24" (610 mm) MINIMUM WHEN BOTTOM OF WOOD OR METAL CABINET IS PROTECTED BY NOT LESS THAN 1/4" (6 mm) FLAME RETARDANT MILLBOARD COVERED WITH NOT LESS THAN NO. 28 MSG SHEET STEEL, 0.015" (0.4 mm) STAINLESS STEEL, 0.024" (0.6 mm) ALUMINUM OR 0.020" (0.5 mm) COPPER. 0" (0 mm) CLEARANCE IS THE MINIMUM FOR THE REAR OF THE RANGE. FOLLOW ALL DIMENSION REQUIREMENTS PROVIDED ABOVE TO PREVENT PROPERTY DAMAGE, POTENTIAL FIRE HAZARD, AND INCORRECT COUNTERTOP AND CABINET CUTS.

TO ELIMINATE THE RISK OF BURNS OR FIRE BY REACHING OVER HEATED SURFACE UNITS, CABINET STORAGE SPACE LOCATED ABOVE THE SURFACE UNITS SHOULD BE AVOIDED. IF CABINET STORAGE IS TO BE PROVIDED, THE RISK CAN BE REDUCED BY INSTALLING A RANGE HOOD THAT PROJECTS HORIZONTALLY A MINIMUM OF 5" (127 mm) BEYOND THE BOTTOM OF THE CABINETS.

